

OSMEN

OUTDOOR LIVING

Cambridge

弘

據《說文》，“弘”本義是弓聲，特指聲音洪大的弓聲。後有通“宏”，帶“大”的形容詞意，又因弓背隆起處是弓彎曲或伸張最關鍵的部分，所以“弘”的動詞意是“擴大、發揚”。

According to Origin of Chinese Characters, the original meaning of “弘(Hong)” is the sound of bow, especially the loud voice of bow. Later, it has the adjective meaning of "macro" and "large". The English name of this product is CAMBRIDGE, in the hope that it will be like the city of Cambridge, with quiet and scholarly fragrance in modernization.



CAMBRIDGE

Available Materials

可選材質



滌綸繩
Polyester



鋁管
Aluminium Tube

柚木
Teak



防水布料
Waterproof Fabric



淡藍色
Light Blue



灰白色
Off White



提花灰白色亞克力布
Jacquard Off White\Acrylic Fabric



淺灰色
Light Grey



深灰色
Charcoal Grey



高級灰色Sunfiber布料
Luxury Grey\Sunfiber



深灰色
Deep Grey



烏雲灰色Sunfiber布料
Cloud\Sunfiber



淺靛藍滌綸布料
Light Indigo\Polyester Fabric

陶瓷基玻璃
Ceramic Based Glass



灰白色
Off White



仿古灰色
Imitated Antique Grey



CAMBRIDGE

Measurements

尺寸

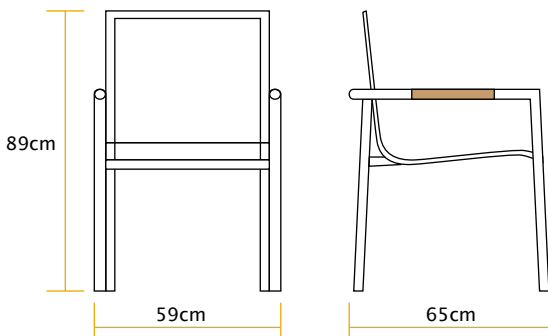
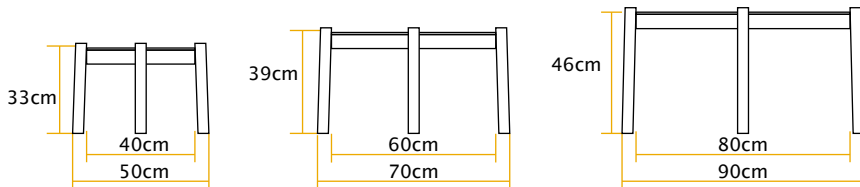
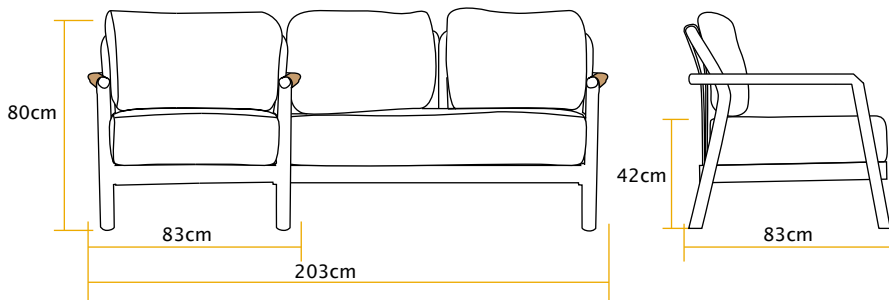

CAMBRIDGE

Optional Combination

可選搭配



弘沙發六件套
CAMBRIDGE Sofa 6pcs

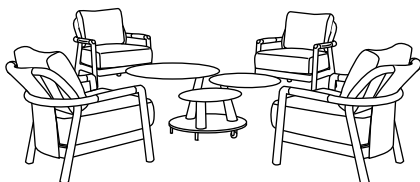

弘沙發五件套
CAMBRIDGE Sofa 5pcs
*蘇拉三朵花旋轉茶幾
SOLA 3 Functional Swivel Table



弘沙發陽臺三件套
CAMBRIDGE Sofa Balcony 3pcs
*尤裏卡茶幾 EUREKA Coffee Table

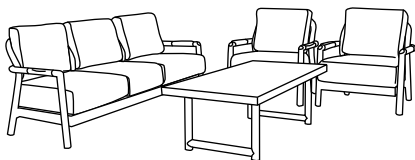

弘沙發四件套
CAMBRIDGE Sofa 5pcs
*塔瑪拉瑪茶幾 TAMARAMA Coffee Table

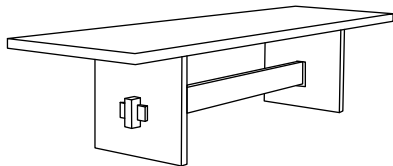

兩扇門餐臺
SIDE & SIDE Dining Table

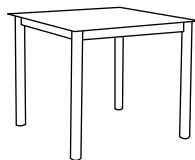

亨登方形餐臺
HERNDON Dining Table